

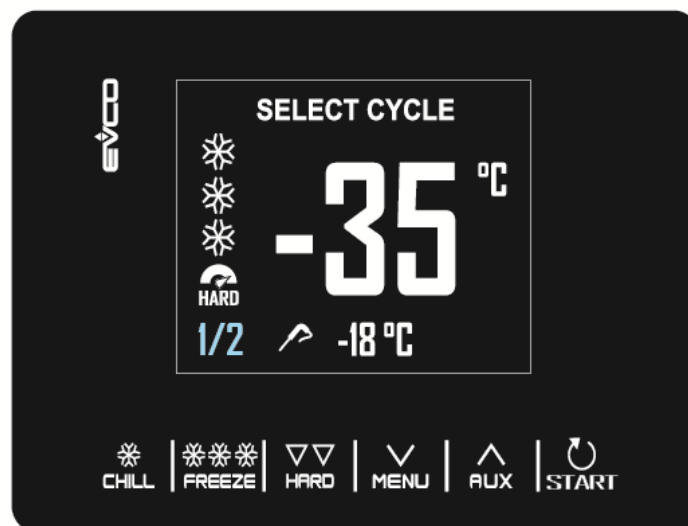

EVJ 800 series

Controllers for blast chillers



ENGLISH

INSTALLER MANUAL ver. 1.0

CODE 144J800E104



Important

Read this document carefully before installation and before using the device and take all the prescribed precautions. Keep this document with the device for future consultation.
Only use the device in the ways described in this document. Do not use the device as safety device.



Disposal

The device must be disposed of according to local regulations governing the collection of electrical and electronic equipment.

Index

1	INTRODUCTION	4	6.4	Pre-cooling	18
1.1	Product description.....	4	6.5	Manual defrosting.....	19
1.2	Models available and hardware features.....	5	6.6	Fish sanitation	20
2	INSTALLATION.....	6	6.7	Ice cream hardening.....	21
2.1	Format features	6	6.8	Thawing	22
2.2	Measurements and installation.....	6	6.9	Cabinet sterilisation	23
2.3	Electrical connection.....	8	6.10	Heating the needle probe	24
3	OPERATING THE DEVICE.....	9	6.11	Recipes	24
3.1	Initial switch-on.....	9	7	MANAGING THE LOADS.....	26
3.2	Power failure	9	7.1	Door frame heating	26
3.3	Silencing the buzzer	9	7.2	Compressor	26
4	DISPLAY	10	7.3	Evaporator fans	27
4.1	Keys.....	10	7.4	Condenser fans.....	27
4.2	Icons	11	7.5	Alarm	28
5	SETTINGS	13	7.6	Needle probe heating.....	28
5.1	Initial information	13	7.7	Cabinet sterilisation.....	28
5.2	Languages	13	7.8	Defrosting	28
5.3	Internal status	13	7.9	Thawing heaters	28
5.4	Parameters	13	7.10	Cabinet light	28
5.5	HACCP alarms	14	8	CONFIGURATION PARAMETERS.....	29
5.6	Restore data.....	14	9	ALARMS	38
5.7	Real time clock	14	9.1	Alarms.....	38
6	FUNCTIONS.....	15	10	TECHNICAL SPECIFICATIONS	42
6.1	Operating cycles	15	10.1	Technical specifications	42
6.2	Needle probe insertion test.....	16			
6.3	Blast chilling/blast freezing and conservation	16			

1 INTRODUCTION

1.1 Product description

Controllers in the EVJ 800 range are capable of performing blast chilling and blast freezing cycles in an intuitive way, both temperature and time controlled, with hard/soft function.

This versatile product provides users with a range of special cycles such as pre-cooling, fish sanitation and ice cream hardening. The outputs are highly configurable thus making it possible to manage the loads needed to run thawing cycles, needle probe heating and cabinet sterilisation.

The Bluetooth BLE connectivity (either built-in or with an EVlink external module) enables access from an Android smartphone with the EVconnect app, making possible configuration, download and exchange of HACCP data and parameter maps.

The user interface has a 2.8 inch colour graphic display, capacitive keys and an IP65 front with a continuous surface. It has been designed for rapid front installation on a plastic or metal panel. For panels in glass or methacrylate, the controller can be installed from behind and all the keys personalised on the panel surface.

1.2 Models available and hardware features

The table below shows the technical features of the models available and the purchasing codes.

	EVJ805P9VX3	EVJ815P9VX3XXV
Power supply		
115...230 VAC	•	•
Analogue inputs		
cabinet probe (PTC/NTC)	•	•
needle probe (PTC/NTC)	•	•
Analogue-digital inputs		
evaporator/condenser probe (PTC/NTC) or multi-purpose digital input	•	•
Digital inputs		
door switch	•	•
Digital outputs		
compressor	30 A	30 A
defrost	8 A	8 A
evaporator fan	8 A	8 A
condenser fan (configurable)	5 A	5 A
needle probe heater (configurable)	5 A	5 A
Communications ports		
TTL MODBUS for EVCO accessories	•	•
Other features		
clock		•
alarm buzzer	•	•
BLE connectivity for EVconnect app	optional with EVLINK	built-in

2 INSTALLATION

2.1 Format features

The controller is available in a compact version with a plastic container and holding flaps.

The user interface has a 2.8 inch colour graphic display, 6 capacitive keys and an IP65 front.

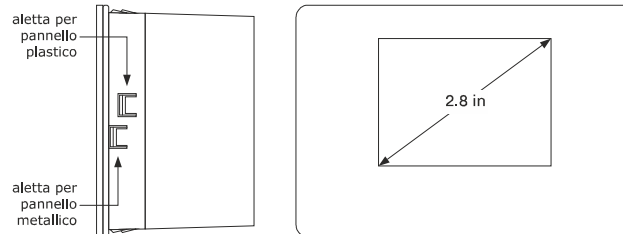

2.2 Measurements and installation

Measurements

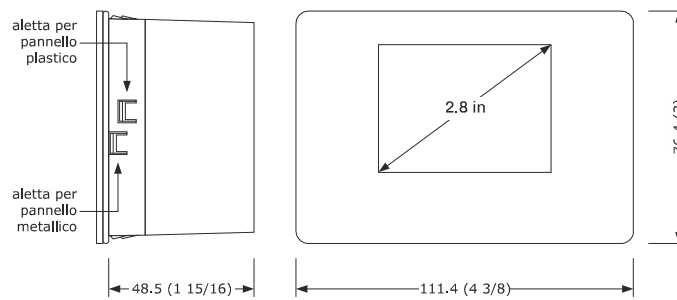

Panel, from the front

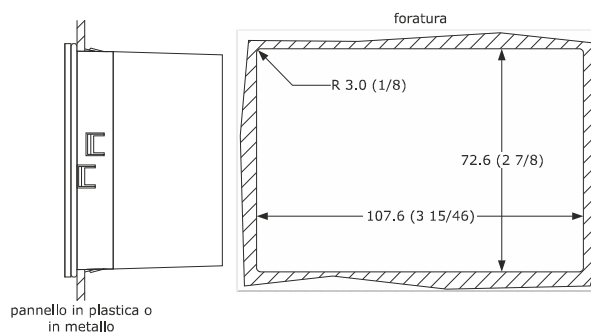

N.B.

The thickness of a metal panel must be between 0.8 and 1.5 mm (1/32 and 1/16 in), while that for a plastic panel must be between 0.8 and 3.4 mm (1/32 and 1/8 in).

Panel, from behind

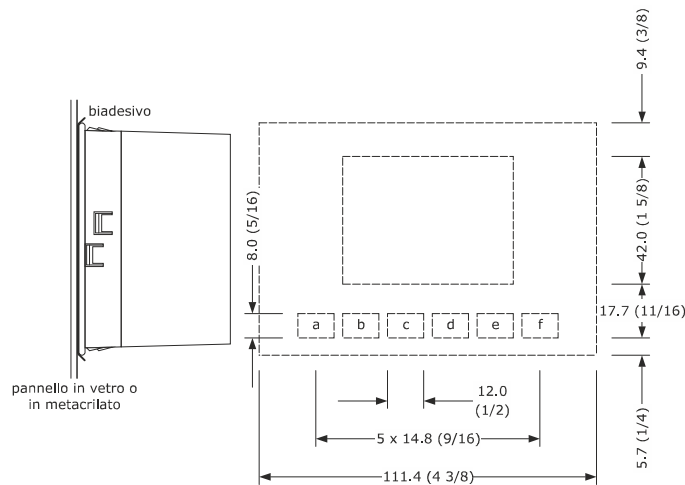

N.B.

- the thickness of a glass panel must be between 2.0 and 4.0 mm (1/16 and 1/8 in), while that for a methacrylate panel must be between 2.0 and 3.0 mm (1/16 and 1/8 in).
- the panel and the material used to carry out screen printing must not contain conductive substances.
- keep the device and the panel at a temperature between 15 and 38°C (59 and 100°F) for about an hour before carrying out the installation.
- before installation, carefully clean the panel surface that will be in contact with the double-sided adhesive tape, making sure that the product used for cleaning is suitable for the panel material (we recommend using isopropyl alcohol, in the case of surfaces greased with a hydrocarbon solvent). Continue cleaning with a cloth until it is clean and dry after use.
- during installation, apply a uniform and constant pressure for about 30 secs on the panel surface in contact with the double-sided adhesive tape. Then leave the device and the panel in a horizontal position for about 48 hours at a temperature between 15 and 38°C (59 and 100°F).

⚠ Installation precautions

- ensure that the working conditions for the device (operating temperature, humidity, etc.) are within the set limits. See section 10 TECHNICAL SPECIFICATIONS.
- do not install the device close to heat sources (heaters, hot air ducts, etc.), equipment with a strong magnetic field (large diffusers, etc.), in places subject to direct sunlight, rain, damp, excessive dust, mechanical vibrations or shocks.
- any metal items close to the control module must be at a sufficient distance so as not to compromise the safety distance; any cabling must be placed at least 2 cm away.
- in compliance with safety regulations, the device must be installed properly to ensure adequate protection from contact with electrical parts. All protective parts must be fixed in such a way as to need the aid of a tool to remove them.

2.3 Electrical connection

EVJ805

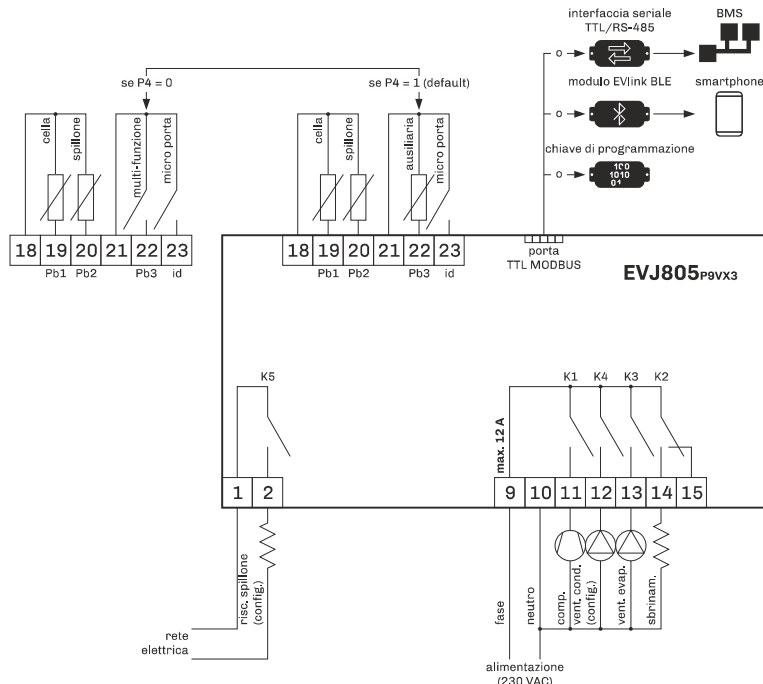

EVJ815

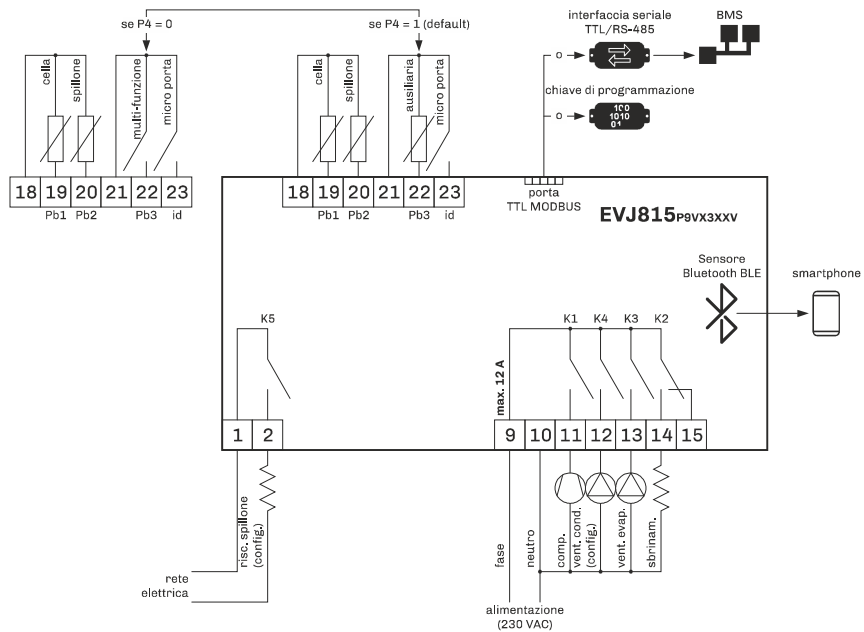

3 OPERATING THE DEVICE

3.1 Initial switch-on

Connect the device to the power supply: a neutral system loading screen will be presented:

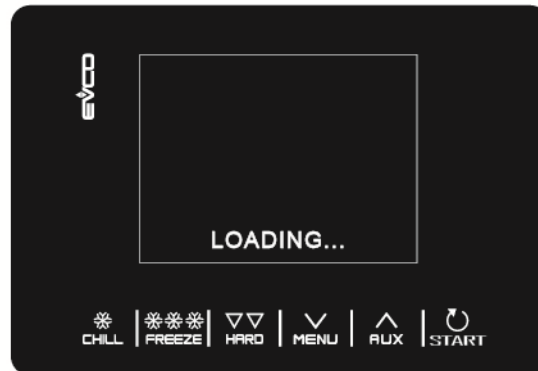

Once loading is complete, the device will display the mode it was in before being powered down:

- on the Home screen with no power failure message;
- carrying out a cycle with the POWER FAILURE message indicating that there had been a loss of power.

3.2 Power failure

If there is a power failure with no function in progress, when power is restored the device will return to the mode set before the failure occurred.

If the power supply fails while a function is active, when power is restored the device will behave as follows:

- if blast chilling or blast freezing was in progress, the cycle will resume, taking into account the duration of the power failure;
- if a conservation cycle was running, the cycle will continue using the same settings.

If the power supply has been cut off long enough to cause a clock error (RTC code), it will be necessary to reset the date and time.

3.3 Silencing the buzzer







To silence the buzzer touch any key while it is sounding.

4 DISPLAY















4.1 Keys

Each of the 6 keys activates different functions depending on the navigation level or the function currently running.



KEYS	FUNCTION
	<ul style="list-style-type: none"> - Enables the quick selection of a blast chilling cycle. - Once a blast chilling cycle has been selected, it makes it possible to switch from temperature controlled blast chilling to time controlled blast chilling and vice versa. - Within a menu or when setting a parameter: acts as the "ESC" key and returns the controller to the page above. - N.B. When a cycle is in progress the key is not active; to stop the cycle press the "START" key for 2 seconds.
	<ul style="list-style-type: none"> - Enables the quick selection of a blast freezing cycle. - Once a blast freezing cycle has been selected, it makes it possible to switch from temperature controlled blast freezing to time controlled blast freezing and vice versa.
	<ul style="list-style-type: none"> - Once the blast chilling/blast freezing cycle has been selected, it makes it possible to switch from hard to soft mode and vice versa.
	<ul style="list-style-type: none"> - From the Home page: gives access to the setting menu. - Within a menu: enables navigation down a level. - During parameter setting: decreases the value of the element to be modified.
	<ul style="list-style-type: none"> - From the Home page: gives access to the menu for selecting special cycles - Within a menu: enables navigation up a level. - During parameter setting: increases the value of the element to be modified.
	<ul style="list-style-type: none"> - Short press: starts the selected function or gives access to the selected menu page. - Long press for 2 seconds: interrupts the cycle in progress - During parameter setting: enables the value to be modified, while pressing a second time confirms the set value.

4.2 Icons

ICON	DESCRIPTION
	Cabinet temperature
	Core temperature
	Blast chilling
	Hard blast chilling
	Blast freezing
	Soft blast freezing
	Time-controlled cycle
	Compressor output on
	Cycle in progress
	Door open The icon will automatically disappear the next time the door is closed or when a key is pressed
	Fish sanitation cycle in progress
	Ice cream hardening cycle in progress
	Thawing cycle in progress
	Number of the phase in progress



Blast chilling/blast freezing cycle completed successfully



Blast chilling/blast freezing cycle not completed successfully

5 SETTINGS

5.1 Initial information

The list of settings is accessed by pressing  on the Home page.

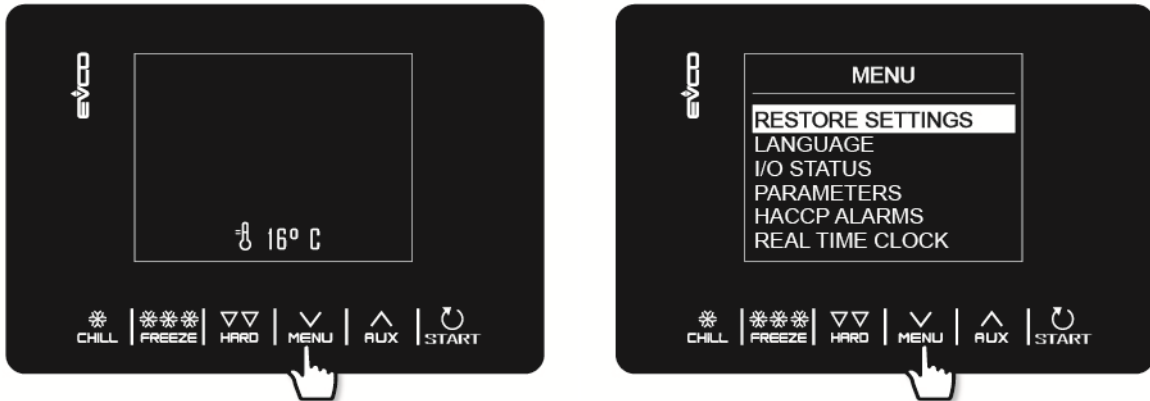

5.2 Languages

The choice of languages consists of Italian, English, French, German, Spanish, Portuguese, Simplified Chinese and Traditional Chinese.

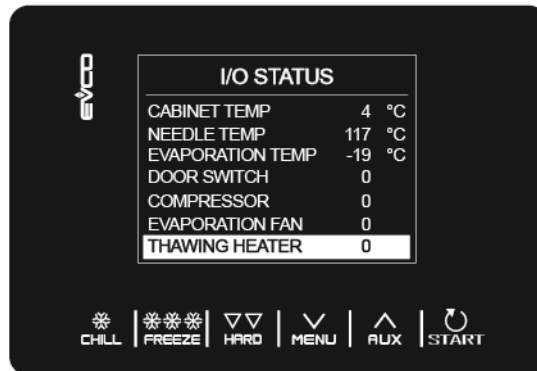

5.3 Internal status

The internal status display menu is shown below.



To return from this menu to the previous screen, press the  key.

5.4 Parameters

To display the parameters, the password -19 must first be entered from the menu using the  key. To change the value of the parameters, select the desired parameter and use the  key to edit it; finally confirm with the  key.

For a complete list of parameters with their respective labels, descriptions and values (default, minimum and maximum), see section 8 CONFIGURATION PARAMETERS.

5.5 HACCP alarms

Access the SETTINGS menu with the **MENU** key, select HACCP ALARMS and press **START** to see the last 9 HACCP alarms stored. If there are no HACCP alarms stored, the display will show the words "NO ALARM".

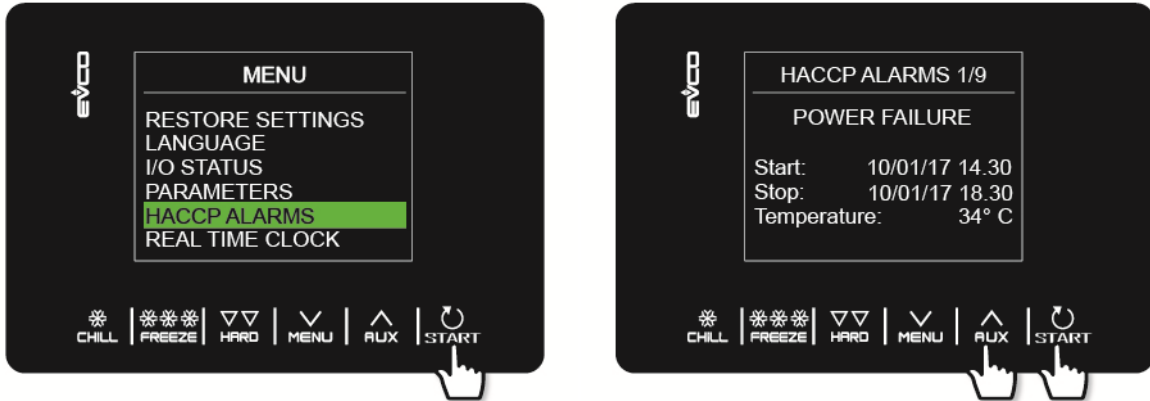

The following HACCP alarms are listed:

- Blast chilling/blast freezing cycle duration
- Power failure
- Door open
- High temperature alarm
- Low temperature alarm

The time of their appearance will only be shown if an RTC is installed.

5.6 Restore data

Access the SETTINGS menu with the **MENU** key, select RESTORE DATA and press **START**. The RESTORE PARAMETERS sub-menu can be accessed by first typing the password 149.

5.7 Real time clock



On the REAL-TIME CLOCK page, if the **START** key is pressed, the 2 digits indicating the year start to flash. The value can be set by using the **MENU** **AUX** keys, and then confirmed by pressing the **START** key. Continue using this procedure to complete the changes. Once the date and time have been set, you will be returned to the previous menu after 50 seconds of inactivity or by pressing the **CHILL** key.

6 FUNCTIONS

6.1 Operating cycles

The device is capable of managing the following **blast chilling and blast freezing cycles**:

- temperature controlled blast chilling and conservation
- hard temperature controlled blast chilling and conservation
- time controlled blast chilling and conservation
- hard time controlled blast chilling and conservation
- temperature controlled blast freezing and conservation
- soft temperature controlled blast freezing and conservation
- time controlled blast freezing and conservation
- soft time controlled blast freezing and conservation

The blast chilling or blast freezing functions can be accessed quickly by pressing the keys  and .

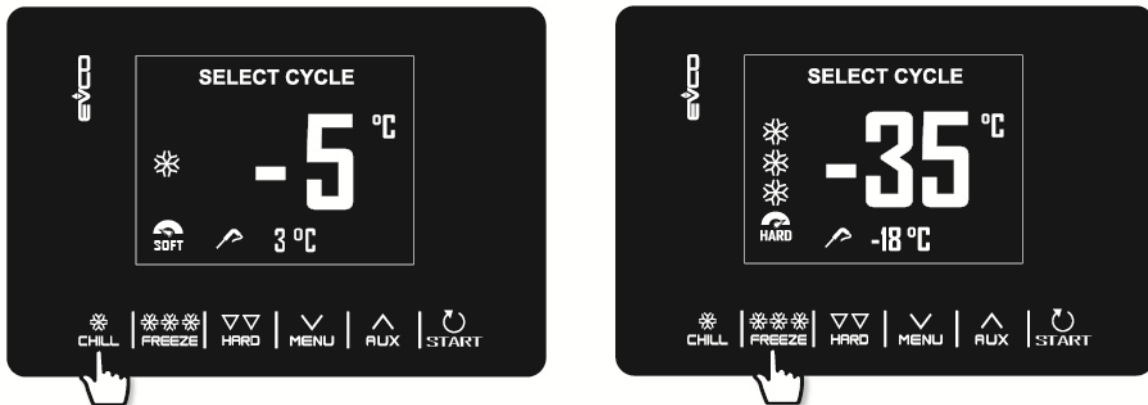

In addition to the blast chilling and blast freezing cycles, the controller is able to manage the following **special cycles**, some of which are always available, while others can be enabled/disabled by parameters u1 (load managed by the K4 output) and u2 (load managed by the K5 output):

- pre-cooling
- manual defrosting
- fish sanitation (available if P3 = 1, i.e. if the needle probe is enabled)
- ice cream hardening
- thawing (available only if u1 is set to 2, i.e. thawing heater)
- cabinet sterilisation (available only if u2 is set to 1, i.e. UV lamp)
- needle probe heating (available only if u2 is set to 2, i.e. needle heater)
- recipes (programmes with predefined cycles)

The SPECIAL CYCLES menu is accessed by pressing the  key.

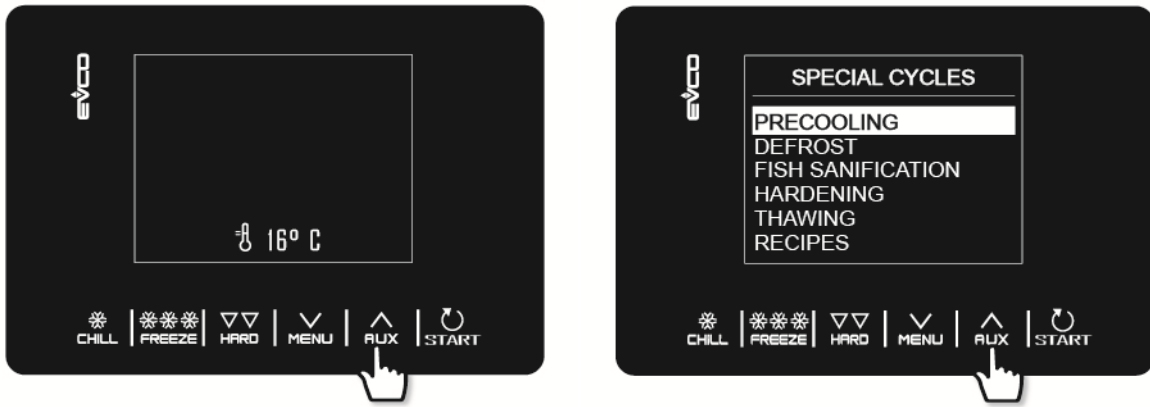

While the cycle is being carried out, the display will show the most significant data:

- when the refrigeration plant is active, the compressor icon at the top left will be illuminated;
- when a recipe is in progress, the blue arrows alternate with the name of the recipe;
- when defrosting is in progress, the word "defrosting" will appear at the top.

The cycle can be stopped at any time by holding down the  key for 2 seconds.

6.2 Needle probe insertion test

If the needle probe is enabled, or if parameter P3 is set to 1, temperature controlled cycles are preceded by a two-phase test to check that the needle probe has been inserted correctly. If the needle probe is not enabled or if parameter P3 is set at 0, only time controlled cycles can be selected.





The test consists of two phases, the second only carried out if the first was not successfully completed.

- Phase one is completed successfully if the gap between the "temperature detected by the needle probe" and the "cabinet temperature" is greater than the value set by parameter r17 in at least three out of five checks (the first check is carried out 10 seconds after the start of the cycle and thereafter at ten-second intervals);
- the second phase is completed successfully if the difference between the "temperature detected by the needle probe" and the "cabinet temperature" is greater than 1°C/1°F as compared to the same check previously carried out, in at least six out of eight checks (the checks being performed at intervals corresponding to 1/8 of the time set by parameter r18).

If the test fails to record a positive outcome, or if the needle probe is not inserted, the buzzer sounds and the cycle automatically changes to time-controlled.

To perform the test, the device waits for the end of any defrosting at the beginning of the cycle and for the door to be closed.

6.3 Blast chilling/blast freezing and conservation

Pressing the  or  keys enables selection of a blast chilling or blast freezing cycle respectively. The device will offer a time or a temperature controlled program depending on the setting of P3: to switch from one mode to the other, press the  or the  key again.

Once the desired cycle has been selected, by pressing the **HARD** key it is possible to add a phase (hard for blast chilling, soft for blast freezing) that will be carried out preliminary to the standard phase, thus changing from a single phase to a two phase cycle.

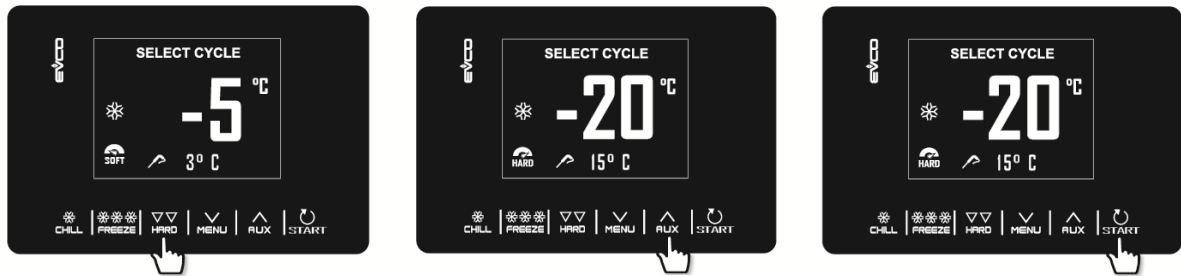

Example of a temperature controlled blast chilling cycle (needle), addition of a hard phase, quick change of the cabinet setpoint for the soft phase and start cycle.

The selected cycle will offer either the pre-loaded settings for that cycle, or the settings of the last cycle carried out (depending on the r36 parameter). By pressing **AUX** **MENU**, it will be possible to quickly change the value of an individual data item (set by parameter r35) within the permitted ranges.

Once the change has been made, press **START** to carry out the cycle.



Example of a temperature controlled blast freezing cycle (needle), conversion to time controlled cycle, quick change of the blast freezing cycle duration and start cycle.

If it is a temperature controlled cycle, a test will be performed to check that the needle probe has been correctly inserted in the food item to be blast chilled. If the test is not successful, the cycle automatically switches to time controlled mode: the buzzer sounds and the type of cycle control is converted from temperature to time on the display. For more details about how to run the test, see section 6.2.



On completion of the blast chilling/blast freezing cycle, when the needle probe has reached the right temperature or the time period is finished, the buzzer sounds and the conservation phase begins. If the temperature controlled cycle is not completed in the allotted time, the problem will be notified by displaying an alarm message.

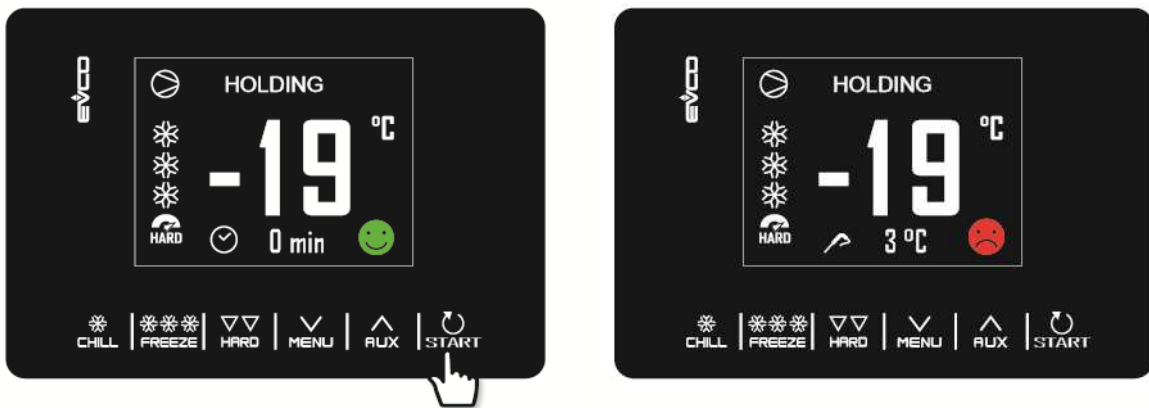

The conservation phase is not timed and is only terminated when the **START** key is pressed for 2 seconds.

Defrosting is always enabled during a conservation phase.

While a cycle is being carried out, by pressing the **MENU** key it is possible to access an advanced page where the working setpoints for the cycle in progress can be modified and all of the machine's internal status data displayed.

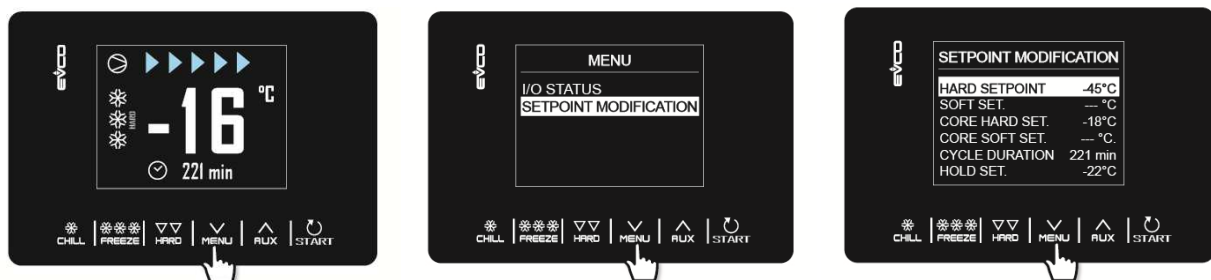

6.4 Pre-cooling

This is a refrigeration cycle of infinite duration that can precede all the operating cycles.

It can also be used as a refrigeration cycle of infinite duration.

Access the SPECIAL CYCLES menu using the **AUX** key and select PRE-COOLING: at this point the working SETPOINT setting screen is displayed, the value of which is given by parameter r12 but which can be modified using the **AUX** **MENU** keys. The next time that the **START** key is pressed the cycle starts.

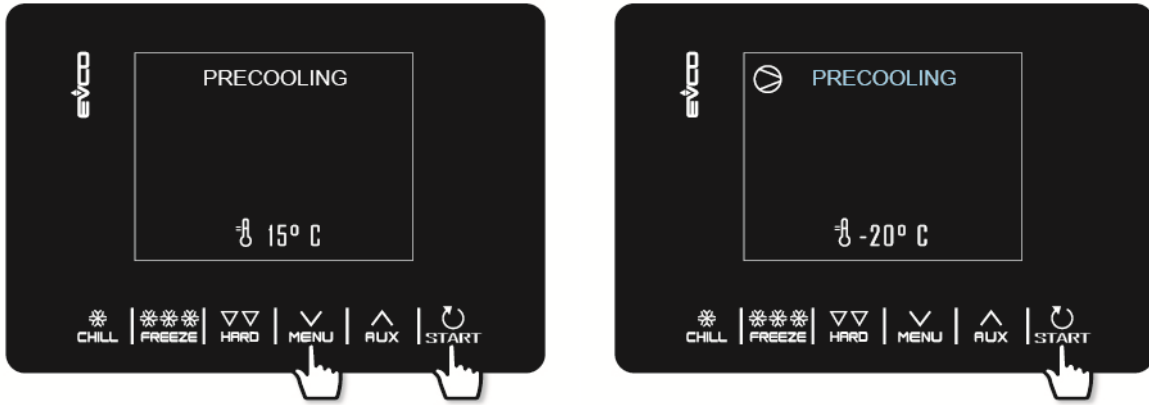

Once the required cabinet setpoint has been reached, the buzzer sounds and the cycle continues and maintains the cabinet temperature achieved until the **START** key is pressed for 2 seconds or until a blast chilling/blast freezing cycle starts up.

If, on the other hand, blast chilling and blast freezing cycles are selected while a pre-cooling program is in progress, the device will display the cycle settings.

During a pre-cooling cycle, defrosting is enabled.

In the event of a power failure, the cycle will be resumed.

6.5 Manual defrosting

A defrosting cycle can be started manually only if certain temperature conditions are met (see parameters d2 and d3). Access the SPECIAL CYCLES menu using the **AUX** key and select DEFROSTING: at this point the word DEFROSTING will appear and the next time **START** is pressed the cycle will start.

If the evaporator probe is present and the conditions for defrosting are not satisfied, when the START key is pressed, the device returns to the SPECIAL CYCLES menu and defrosting is not carried out.

If a defrosting is set to be carried out with the door open (d1=3), the message "OPEN DOOR" will be displayed if it is closed.

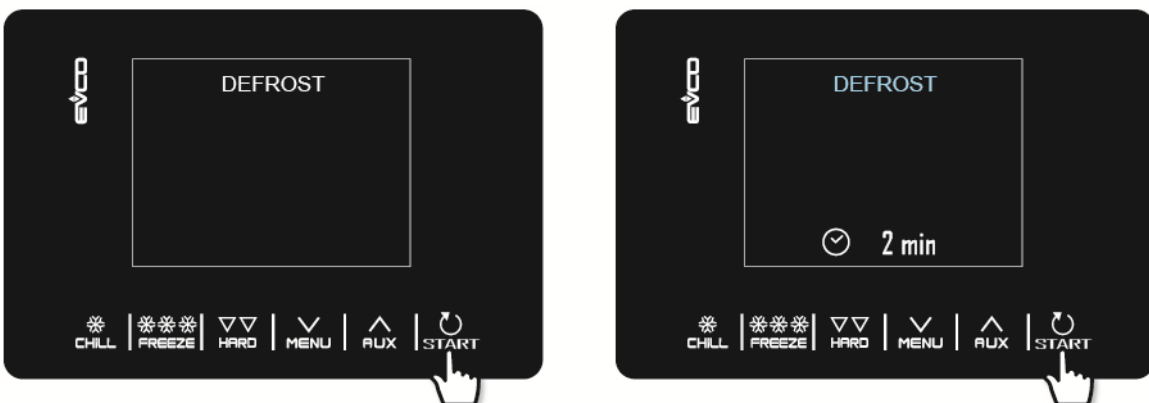

Defrosting can also be carried out automatically during conservation or pre-cooling at time intervals set by parameter d0, provided that this value is not set to 0.

Regardless of how they have been started up, defrosting cycles are managed by the following parameters.

d0	interval between two consecutive defrosts
d1	type of defrost
d2	evaporator temperature to end defrost (can be set if P4 is set to 1)
d3	defrost duration
d4	defrost start-up at the beginning of a blast chilling/blast freezing cycle
d5	defrost start-up delay from the start of conservation after blast chilling/blast freezing
d7	drip duration
d15	minimum compressor switch-on duration for starting hot gas defrost
d16	pre-drip duration (can be set if hot gas defrost is selected)

The type of defrost can be selected by parameter d1. There are four ways of performing a defrost cycle.

d1=0	electric defrost
d1=1	hot gas defrost
d1=2	air defrost
d1=3	air defrost with door open

Defrosting is activated automatically at the start of a blast chilling/blast freezing cycle if d4=1. Regardless of the parameter d4 value, automatic defrost is activated with a delay as compared to the beginning of the conservation phase set by parameter d5.



If the evaporator probe is present when a defrost cycle is to be activated, this only starts if the temperature indicated by the evaporator probe is lower than the value of parameter d2.

Defrosting finishes when the evaporator temperature is above the value of parameter d2 or if the temperature has not been reached within the required time set by parameter d3.

When pre-cooling is in progress, a defrosting cycle cannot be started.

6.6 Fish sanitation

The fish sanitation cycle is only available with the use of a needle probe.

Access the SPECIAL CYCLES menu using the  key and select FISH SANITATION: at this point the start up screen will appear and the next time  is pressed the cycle will start.

This special cycle consists of the following phases:

- blast chilling with the cabinet setpoint set by parameter r19 and with the product temperature setpoint set by parameter r20;
- holding for the time period set by parameter r21 and the cabinet setpoint given by r20;
- conservation with the cabinet setpoint given by r22.

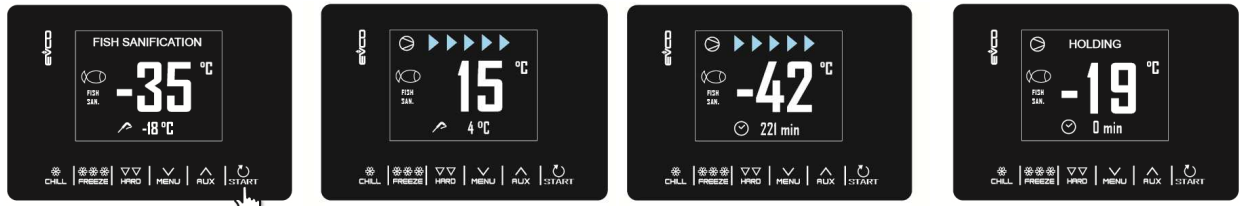

During a sanitation cycle, the device will always display the cabinet temperature and, depending on the phase in progress, the blast chilling end temperature or the duration of the holding phase.

The sanitation cycle starts with the blast chilling phase. When the temperature recorded by the needle probe reaches the temperature to end blast chilling, the device will move on automatically to holding.

The temperature to end blast chilling (set by r20) is also the working setpoint during holding.

When the holding period has elapsed, the device will move on automatically to conservation.

The needle insertion test is always carried out at the start of the cycle: if the test is not completed, the buzzer sounds and the cycle is interrupted.

The cycle may be interrupted early by pressing the **START** key for 2 seconds.

The start of a sanitation cycle locks any pre-cooling cycle in progress.

6.7 Ice cream hardening

This type of cycle is used primarily in the ice cream and pastry-making industries to give the products being worked a “thermal shock”. This is a continuous blast freezing cycle: once the cabinet setpoint given by parameter r8 has been reached, countdown of the time set by r24 will restart each time the door is opened.

Access the SPECIAL CYCLES menu from the **AUX** key and select ICE CREAM HARDENING: at this point the start screen is displayed, from which you can change the timer settings using the **AUX** and **MENU** keys. The next time that **START** is pressed, the cycle will begin and the expiry of the preset time will be signalled by the buzzer. The cycle will, however, continue until the **START** key is pressed and held for 2 seconds.

The start of an ice cream hardening cycle locks any pre-cooling cycle in progress.



6.8 Thawing

The thawing cycle is only available if the load managed by the K4 output is the thawing heater (u1 = 2).

Access the SPECIAL CYCLES menu from the **AUX** key and select THAWING: at this point the start screen is displayed, from which you can select the quantity of the product to be thawed using the **AUX** and **MENU** keys. The next time that the **START** key is pressed the cycle starts.

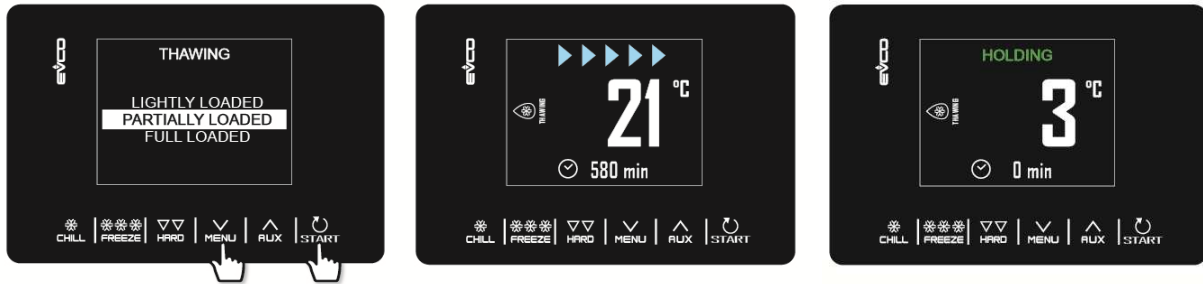

The defrosting cycle is managed on the basis of the amount of product to be defrosted that is loaded into the unit in relation to the maximum quantity specified by the manufacturer. To keep it simple, the load quantities that can be selected are divided into three bands, for each of which the controller will load three different sets of predefined parameters, in accordance with the following scheme:

Load band	Initial cabinet setpoint	Final cabinet setpoint	Cycle duration
LIGHT LOAD	r25	r28	r32
MEDIUM LOAD	r26	r29	r33
FULL LOAD	r27	r30	r34

These three parameters will be used to control the working cabinet setpoints and the duration of the thawing cycle, equally divided into five phases following on from each other as shown.

- Phase 1 working setpoint = initial setpoint
- Phase 2 working setpoint = phase 1 setpoint + [(initial setpoint - final setpoint) / 4]
- Phase 3 working setpoint = phase 2 setpoint + [(initial setpoint - final setpoint) / 4]
- Phase 4 working setpoint = phase 3 setpoint + [(initial setpoint - final setpoint) / 4]
- Phase 5 working setpoint = final setpoint

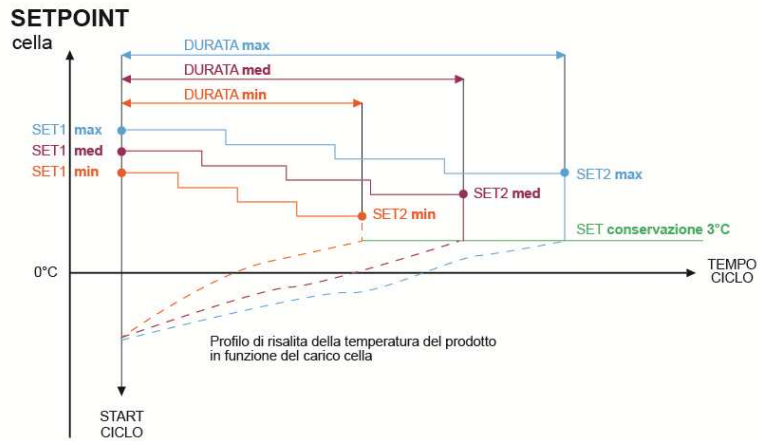

set 1 = initial setpoint
set 2 = final setpoint

Five parameters are used to manage the ventilation (one for each phase). The parameters define the fan operation as either continuous or in parallel with the compressor/thawing heater. These parameters are: F29, F30, F31, F32, F33. At the end of the thawing cycle the buzzer sounds, after which the machine moves on to a conservation phase, its setpoint set by parameter r31 for an indefinite period. Defrosting cycles cannot be carried out during thawing, whereas automatic defrosting (at intervals set by parameter) is possible during the post-defrosting conservation phase. If the door is opened, the machine will operate based on the value of parameter i0.

6.9 Cabinet sterilisation

Cabinet sterilisation is a cycle that is only available if the load managed by output K5 is the UV lamp (u2 = 1). In order to carry out a sterilisation it is essential that there is no pre-cooling taking place and that the door is closed. Access the SPECIAL CYCLES menu using the **AUX** key and select STERILISATION: at this point the start screen will appear and the next time **START** is pressed the cycle will start.

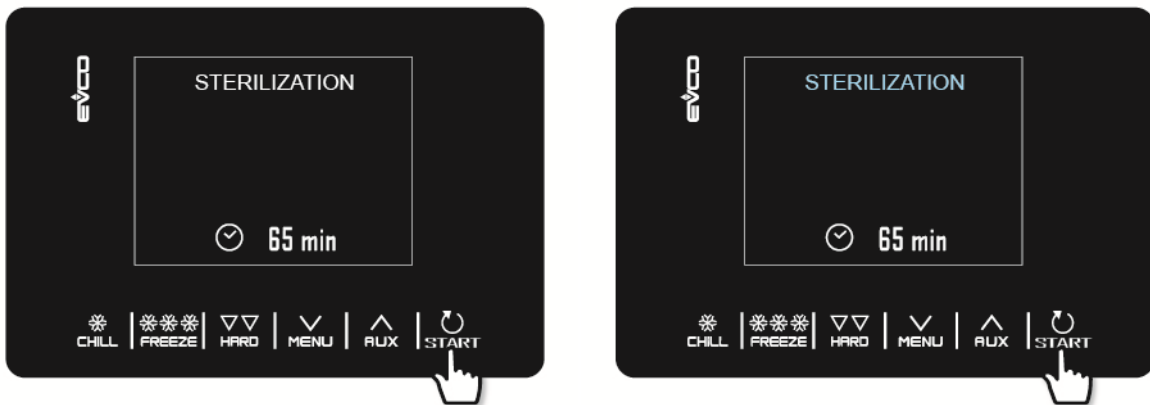

Sterilisation ends when the time set by parameter u6 has elapsed, after the **START** key has been pressed for 2 seconds or if the door is opened. During sterilisation the cabinet sterilisation relay is active. If parameter u11 is set to 1, the evaporator fans are also active.

The display will show the count-down for the remaining time. At the end of the cycle the buzzer sounds for 1 second and the device returns to the Home page.

6.10 Heating the needle probe

Heating of the needle probe is a cycle that is only available if the load managed by the K5 output is the needle probe heater (u2 = 2).

The heating must be carried out with the door open but if the door is closed once the cycle has already started, it does not affect its functioning.

Access the SPECIAL CYCLES menu from the **▲ AUX** key and select NEEDLE HEATING: at this point the start screen will appear. The next time that **○ START** is pressed the cycle will start, but it can be interrupted at any time by pressing and holding the **○ START** key down for 2 seconds.

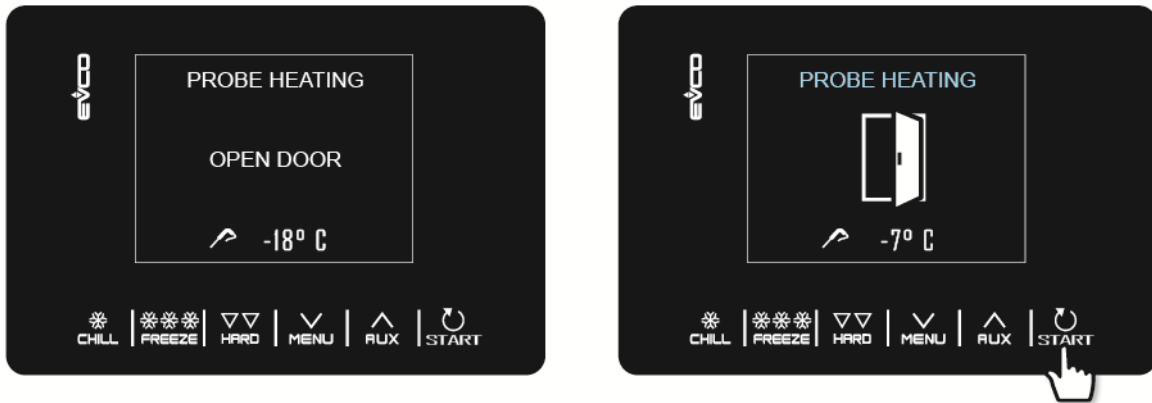

The needle probe heating output is activated at maximum for the time set by parameter u8 or until the temperature indicated by the needle probe has reached that set by parameter u7.

At the end of the heating, the buzzer sounds for one second and the device returns to the Home page.

6.11 Recipes

Recipes are preset ready-to-use programs that offer a series of cycles optimised by type of dish. When P3 is set to 0, any recipes that call for a setpoint for the needle probe are not displayed.

The recipes can be modified before starting the cycle, but cannot be saved or over-written.

Access the SPECIAL CYCLES menu from the **▲ AUX** key and select RECIPES to see the list of predefined blast chilling/blast freezing programs available. Using the **▲ AUX** **▼ MENU** keys select the desired recipe, change the setpoint if necessary and start the cycle by pressing the **○ START** key.

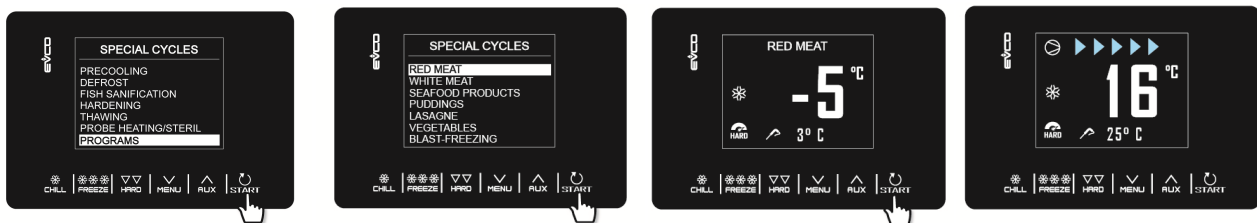

RED MEATS - NEEDLE PROBE

Phase 1	Cabinet setpoint	-25°C
	Needle probe setpoint	20°C
Phase 2	Cabinet setpoint	-5°C
	Needle probe setpoint	3°C
Conservation	Cabinet setpoint	2°C

WHITE MEATS

Phase 1	Cabinet setpoint	-25°C
	Duration setpoint	27 min
Phase 2	Cabinet setpoint	-5°C
	Duration setpoint	63 min
Conservation	Cabinet setpoint	2°C

SEAFOOD PRODUCTS

Phase 1	Cabinet setpoint	-25°C
	Duration setpoint	27 min
Phase 2	Cabinet setpoint	-5°C
	Duration setpoint	63 min
Conservation	Cabinet setpoint	2°C

CREAMS

Phase 1	Cabinet setpoint	-5°C
	Duration setpoint	90 min
Conservation	Cabinet setpoint	2°C

LASAGNE

Phase 1	Cabinet setpoint	-5°C
	Duration setpoint	90 min
Conservation	Cabinet setpoint	2°C

VEGETABLES

Phase 1	Cabinet setpoint	-5°C
	Duration setpoint	90 min
Conservation	Cabinet setpoint	2°C

QUICK NEEDLE PROBE BLAST FREEZING

Phase 1	Cabinet setpoint	0°C
	Needle probe setpoint	3°C
Phase 2	Cabinet setpoint	-12°C
	Needle probe setpoint	-3°C
Phase 3	Cabinet setpoint	-30°C
	Needle probe setpoint	-18°C
Conservation	Cabinet setpoint	-20°C

7 MANAGING THE LOADS

7.1 Door frame heating

The output is present only if the load managed by output K4 is the door frame heater ($u1 = 0$).

This function is activated automatically when the controller is switched on or is in operation and the temperature in the cabinet falls below the value set by parameter $u5$. The output is deactivated when the temperature rises above the $u5$ parameter +2 °C.

If there is a cabinet probe error, the heaters are not activated, or if already on, they are deactivated.

Opening the door deactivates the heater.

7.2 Compressor

The management of the compressor varies according to the cycle activated, as specified below.

Blast chilling, blast freezing, pre-cooling, ice cream hardening, sanitation

The compressor is activated if the cabinet temperature is above the setpoint for the type of cycle underway + the hysteresis set by parameter $r0$. It is deactivated when the temperature falls below the setpoint for the phase underway.

The compressor must be switched on and off according to the safety periods set by parameters $C0$, $C1$, $C2$ and $C3$.

The drip periods must also be complied with if it is activated after a defrost cycle.

If there is a fault with the cabinet probe during a conservation cycle, the compressor is activated on a cyclical basis according to the values of parameters $C4$ and $C5$ if this is a conservation phase following blast chilling, or according to the values of parameters $C4$ and $C9$ for conservation following blast freezing.

Defrosting

During defrosting the compressor status depends on the value of parameter $d1$. If $d1$ equals 0, 2 or 3, the compressor is switched off.

If $d1$ equals 1, the compressor will remain switched on for the entire duration of the defrost cycle and if it is switched off when the defrost cycle is selected, it will be switched on for the period set by parameter $d15$ before defrosting starts. When defrosting is finished the compressor remains off for the period set by parameter $d7$.

If parameter $d16$ is set to a value other than 0, when a hot gas defrost cycle starts the compressor remains off for the pre-drip time set by parameter $d16$.

Thawing

The compressor switches on if the cabinet temperature is equal to or higher than $SP + r38 + r40$, where SP is the working setpoint based on the load band, $r38$ is the neutral zone relative threshold and $r40$ is the cabinet setpoint differential for activating the compressor. It switches off if the cabinet temperature is equal to or lower than $SP + r38$.

7.3 Evaporator fans

The management of the evaporator fans varies according to the cycle activated, as specified below. Moreover, the management mode varies according to whether the evaporator probe is present, which can be enabled by setting parameter P4 to 1.

Blast chilling, blast freezing, ice cream hardening, fish sanitation, pre-cooling

The fans are always switched on and are only switched off if the cabinet temperature is equal to or higher than the parameter F17 + F8 and/or the evaporator probe temperature is equal to or higher than the parameter F1 + F8. They are only switched on again if the cabinet temperature falls below the F17 value and that of the evaporator probe falls below F1.

Conservation

The operation of the fans during conservation depends on parameter F49: if set to 0 (default), they will work in parallel with the compressor, if set to 1 they will be always active.

Thawing

Phase by phase it is possible to select whether the fans are always active or if they are to work in parallel with the compressor or thawing heater outputs.

Defrosting

During defrosting the evaporator fans are switched off if the parameter d1 value is set to 0 or 1. They are switched on if d1 is set to 2 or if the door is open with d1 set at 3.

At the end of the defrosting cycle, the fans remain off for the time set by parameter F3. To set an effective fan stop, the time relative to F3 must be greater than the dripping time set by parameter d7.

7.4 Condenser fans

Output present only with u1 = condenser fan

The condenser fan management mode varies depending on the presence or otherwise of the condenser probe, which can be enabled by setting parameter P4 to 2. The condenser fan management differs based on the following specific situations.

Condenser probe enabled (P4=2)

The fans are always active if the compressor is switched on. If the compressor is switched off they are only activated if the condenser probe value is above the parameter F46 + the differential of 2°C/4°F. They are deactivated if the temperature is below the F46 parameter.

Condenser probe not enabled (P4≠2)

The condenser fans are active if the compressor is active. They are deactivated with a delay set by parameter F47, when the compressor is deactivated.

Condenser probe enabled but faulty

The fans are activated if the compressor is activated and they are deactivated with a delay set by parameter F47.

Defrosting

The fans are managed according to the value set by parameter F48 (on or off).

7.5 Alarm

Output present only with u2 = 3 (alarm).

This activates when an alarm is set off and deactivates when the alarm stops.

7.6 Needle probe heating

Output present only with u2 = 2 (needle heating).

To activate this cycle, the door must be open, but closing it after the cycle has started does not affect the operation.

This output is activated by the user when the needle probe has to be removed from the blast chilled product. The output remains active until the temperature indicated by the needle probe reaches the value set by parameter u7. If within the time period set by parameter u8 this temperature is not reached, the needle probe heating function is deactivated.

7.7 Cabinet sterilisation

Output present only with u2 = 1 (UV light).

During a sterilisation cycle the door must be closed and the output activates for the time period set by parameter u6.

Ventilation can also be activated by setting parameter u11 to 1.

7.8 Defrosting

During defrosting outputs are managed according to the type of defrost set by parameter d1.

The defrost output will be activated regardless of the value of parameter d1 for the entire duration of the defrost.

7.9 Thawing heaters

Output present only with u1 = 2 (thawing heater).

The heaters are activated during defrosting to bring the temperature in the cabinet to the setpoint value in accordance with the cabinet temperature formula $\leq SP - r38 - r39$, where SP is the working setpoint during defrosting, r38 is the neutral zone relative threshold and r39 is the cabinet setpoint differential for activating the heater. The heaters are deactivated when the cabinet temperature $\geq SP - r38$.

Activation takes place with on/off cycles established by parameters r42 (heater on time for thawing) and r41 (heater cycle time for thawing).

7.10 Cabinet light

Output present only with u2 = 0 (cabinet light).

If present, the light comes on when the door is opened and switches off when it is closed.

8 CONFIGURATION PARAMETERS

The parameters are set by default in °C and the relative values and limits are shown in the table in this unit of measurement. In order for the controller to display the values in °F, set P2 to 1 and after the change, disconnect the power from the device and then reconnect it. Any previously stored blast chilling and blast freezing programs will return to the default value each time that P2 is reset.

N.B.

- Because some functions are managed according to the value set for some parameters, ensure these are set correctly and consistently.
- It is not possible to set any value beyond the minimum and maximum limits indicated in the table.
- After changing the parameters, it is advisable to disconnect the power from the device and then reconnect it.

The following table gives the meaning of the configuration parameters.

PAR.	DEFAULT	MIN.	MAX.	U.M.	ANALOGUE INPUTS
CA1	0	-25	25	°C	Cabinet probe offset
CA2	0	-25	25	°C	Evaporator probe offset (if P4=1)
CA3	0	-25	25	°C	Condenser probe offset (if P4=2)
CA4	0	-25	25	°C	Needle probe offset (if P3=1)
P0	0	0	1	----	Type of probe 0 = PTC 1 = NTC
P2	0	0	1	----	Temperature measurement unit 0 = °C 1 = °F
P3	1	0	1	----	Enable needle probe 0 = no 1 = yes
P4	1	0	3	----	Configuration of third measurement input 0 = input disabled 1 = evaporator probe 2 = condenser probe 3 = multi-purpose digital input
PAR.	DEFAULT	MIN.	MAX.	U.M.	MAIN REGULATOR
r0	2	1	15	°C	Cabinet setpoint differential in blast chilling, blast freezing, sanitation, ice cream hardening
r1	90	1	500	min	Duration of time controlled blast chilling
r2	240	1	500	min	Duration of time controlled blast freezing
r3	3	-50	99	°C	Product temperature to end temperature controlled blast chilling and to end the soft phase in temperature controlled soft

					freezing; see also parameter r5
r4	-18	-50	99	°C	Product temperature to end temperature controlled blast freezing; see also parameter r6
r5	90	1	500	min	Maximum permitted duration for temperature controlled blast chilling; see also parameter r3
r6	240	1	500	min	Maximum permitted duration for temperature controlled blast freezing; see also parameter r4
r7	0	-50	99	°C	Cabinet temperature setpoint during blast chilling and the soft phase of soft blast freezing; see also parameter r0
r8	-40	-50	99	°C	Cabinet temperature setpoint during blast freezing and ice cream hardening; see also parameter r0
r9	-20	-50	99	°C	Cabinet temperature setpoint during the hard phase of hard blast chilling; see also parameter r0
r10	2	-50	99	°C	Cabinet temperature setpoint during conservation after blast chilling and hard blast chilling; see also parameter r0
r11	-20	-50	99	°C	Cabinet temperature setpoint during conservation after blast freezing and soft blast freezing; see also parameter r0
r12	5	-50	99	°C	Cabinet temperature setpoint during pre-cooling; see also parameter r0
r13	15	-50	99	°C	Product temperature to end the hard phase of hard temperature controlled blast chilling
r14	60	10	100	%	Duration of the hard phase of hard time controlled blast chilling (i.e. the percentage of the value set by parameter r1). Duration of the soft phase of time controlled soft blast freezing (i.e. the percentage of the value set by parameter r2)
r15	65	-50	199	°C	Product temperature below which the count for maximum duration begins for temperature controlled blast chilling or blast freezing
r17	5	0	99	°C	Minimum gap between the product and cabinet temperatures, according to which the first phase of the test for correct insertion of the needle probe is considered successfully completed 0 = the test is disabled and the needle probe is considered always inserted
r18	80	10	999	s	Duration of the second phase of the test for correct insertion of the needle probe
r19	-40	-50	+99	°C	Cabinet temperature setpoint for the first phase of sanitation

r20	-20	-50	99	°C	Product temperature setpoint for the first phase of sanitation and cabinet temperature setpoint for the second phase of sanitation
r21	24	0	24	h	Duration of second sanitation phase
r22	-20	-50	99	°C	Cabinet temperature setpoint for the third phase of sanitation
r23	5	1	99	h	Maximum duration of the first sanitation phase
r24	10	1	400	min	Duration of ice cream hardening cycle
r25	25	-50	99	°C	Initial cabinet temperature setpoint for light-load thawing
r26	30	-50	99	°C	Initial cabinet temperature setpoint for medium-load thawing
r27	35	-50	99	°C	Initial cabinet temperature setpoint for heavy-load thawing
r28	10	-50	99	°C	Final cabinet temperature setpoint for light-load thawing
r29	12	-50	99	°C	Final cabinet temperature setpoint for medium-load thawing
r30	15	-50	99	°C	Final cabinet temperature setpoint for heavy-load thawing
r31	3	-50	99	°C	Cabinet temperature setpoint for post-thawing conservation
r32	240	1	999	min	Light-load thawing duration
r33	480	1	999	min	Medium-load thawing duration
r34	720	1	999	min	Heavy-load thawing duration
r35	0	1	1	- - - -	Value that can be set in quick mode during the cycle selection phase before starting the cycle itself 0 = working setpoint during the cycle (or cycle final phase setpoint for 2-phase cycles) 1 = end-of-cycle needle temperature (for temperature controlled cycles) or cycle duration (for time controlled cycles)
r36	0	1	1	- - - -	Storing the set value in quick mode during the cycle selection phase 0 = no: at the start of the next cycle the default values of the parameters will be re-offered 1 = yes: at the start of the next cycle the values last used by the same cycle type will be repeated
r37	80	-50	99	°C	Maximum cabinet temperature setpoint that can be set
PAR.	DEFAULT	MIN.	MAX.	U.M.	HEATING REGULATOR
r38	1	0	10	°C	Neutral zone relative threshold for thawing
r39	2	1	15	°C	Cabinet setpoint differential for activating heater during thawing
r40	2	1	15	°C	Cabinet setpoint differential for activating compressor during thawing
r41	45	1	600	s	Heater cycle time for thawing
r42	4	1	600	s	Heater on time for thawing

PAR.	DEFAULT	MIN.	MAX.	U.M.	COMPRESSOR PROTECTION
C0	0	0	240	min	Minimum time between restoration of power supply after a power failure occurring during an operating cycle and compressor switch-on
C1	5	0	240	min	Minimum time between two consecutive compressor switch-ons
C2	3	0	240	min	Minimum time between compressor switch-off and subsequent switch-on
C3	0	0	240	s	Minimum compressor-on time
C4	10	0	240	min	Compressor-off time during cabinet probe error ("CABINET PROBE" code) occurring during conservation after blast chilling and blast freezing; see also parameters C5 and C9
C5	10	0	240	min	Compressor-on time during cabinet probe error ("CABINET PROBE" code) occurring during conservation after blast chilling; see also parameter C4
C6	80	0	199	°C	Condenser temperature above which the condenser overheating alarm is activated ("COND OVERHEATING" code)
C7	90	0	199	°C	Condenser temperature above which the compressor locked alarm is activated ("COMP LOCKED" code), once the time set for C8 has elapsed
C8	1	0	15	min	Activation delay of the compressor locked alarm ("COMP LOCKED" code) due to threshold C7 exceeded
C9	30	0	240	min	Compressor-on time during cabinet probe error ("CABINET PROBE" code) occurring during conservation after blast freezing; see also parameter C4
PAR.	DEFAULT	MIN.	MAX.	U.M.	DEFROST
d0	8	0	99	h	Defrost interval 0 = defrosting during conservation is never activated
d1	1	0	3	- - - -	Type of defrost 0 = electrical (during defrosting the compressor is switched off, the defrost output is activated and the evaporator fan switched off) 1 = hot gas (during defrosting the compressor is switched on, the defrost output is activated and the evaporator fan is switched off) 2 = air (during defrosting the compressor is switched off and the defrost output is activated. The evaporator fan is switched on, regardless of the door status, or regardless of the status of the door switch input) 3 = air with door open (during defrosting the compressor is switched off and the defrost output is activated. The evaporator fan is switched on, provided the door is open or provided the door switch input is on and that parameter i0 is set to a value other than 0)
d2	2	-50	99	°C	Evaporator temperature to end defrosting; see also parameter d3

d3	30	0	99	min	<p>If the evaporator probe is not present (P4=0), it sets the defrost duration</p> <p>If the evaporator probe is present (P4=1), it sets the maximum defrost duration. See also parameter d2</p> <p>0 = defrost is never activated</p>
d4	0	0	1	----	<p>Enable defrost at the start of blast chilling and of blast freezing</p> <p>0 = no</p> <p>1 = yes</p>
d5	30	0	99	min	<p>Defrost delay from the beginning of conservation</p> <p>0 = defrost starts as soon as conservation is started and is repeated in accordance with parameter d0</p>
d7	2	0	15	min	<p>Drip time after a defrost, in which the compressor and the evaporator fan are switched off and the defrost output is deactivated</p>
d15	0	0	99	min	<p>Minimum consecutive compressor-on duration for starting hot gas defrost, if d1 is set to 1</p>
d16	0	0	99	min	<p>Pre-drip time if d1 is set to 1 (hot gas defrost), in which the compressor and the evaporator fan are off and the defrost output remains activated</p>
PAR.	DEFAULT	MIN.	MAX.	U.M.	TEMPERATURE ALARMS
A1	10	0	99	°C	<p>Cabinet temperature below which the minimum temperature alarm is activated (relative to the working setpoint, i.e. "r10-A1" during conservation after blast chilling and "r11-A1" during conservation after blast freezing ("LOW TEMPERATURE" code);</p> <p>see also parameter A11</p>
A2	1	0	1	----	<p>Enable minimum temperature alarm ("LOW TEMPERATURE" code):</p> <p>0 = no</p> <p>1 = yes</p>
A4	10	0	99	°C	<p>Cabinet temperature above which the maximum temperature alarm is activated (relative to the working setpoint, i.e. "r10+A4" during conservation after blast chilling and "r11+A4" during conservation after blast freezing ("HIGH TEMPERATURE" code);</p> <p>see also parameter A11 (4)</p>
A5	1	0	1	----	<p>Enable maximum temperature alarm ("HIGH TEMPERATURE" code):</p> <p>0 = no</p> <p>1 = yes</p>
A7	15	0	240	min	<p>Temperature alarm delay ("HIGH TEMPERATURE" code and "LOW TEMPERATURE" code)</p>

A8	15	0	240	min	Maximum temperature alarm delay (" HIGH TEMPERATURE " code) from the start of conservation
A10	5	0	240	min	Power failure duration sufficient for the power failure alarm to be saved (" POWER FAILURE " code) when this is restored 0 = alarm not signalled
A11	2	1	15	°C	Parameter A1 and A4 differential
A12	5	0	240	s	Duration of buzzer activation on completion of blast chilling and blast freezing
A13	60	0	240	s	Duration of alarm buzzer activation
PAR.	DEFAULT	MIN.	MAX.	U.M.	EVAPORATOR AND CONDENSER FANS
F1	-1	-50	99	°C	Evaporator temperature above which the evaporator fan switches off during pre-cooling/blast chilling/blast freezing/sanitation/ice cream hardening see also parameter F8
F3	2	0	15	min	Duration of evaporator fan-off time (while the evaporator fan is off the compressor may be switched on, the defrost output is de-activated and the evaporator fan stays off)
F8	2	1	15	°C	Parameter F1 and F17 differential
F15	15	0	240	s	Evaporator fan delay from when the door is closed, or the door switch input is deactivated
F17	90	-50	199	°C	Cabinet temperature above which the evaporator fan switches off during pre-cooling/blast chilling/blast freezing/sanitation/ice cream hardening; see also parameter F8
F29	0	0	1	----	Fan operating mode during first phase of thawing: 0 = in parallel with the compressor and thawing heater 1 = always on
F30	0	0	1	----	Fan operating mode during second phase of thawing: 0 = in parallel with the compressor and thawing heater 1 = always on
F31	0	0	1	----	Fan operating mode during third phase of thawing: 0 = in parallel with the compressor and thawing heater 1 = always on
F32	0	0	1	----	Fan operating mode during fourth phase of thawing: 0 = in parallel with the compressor and thawing heater 1 = always on
F33	0	0	1	----	Fan operating mode during fifth phase of thawing: 0 = in parallel with the compressor and thawing heater 1 = always on
F46	15	0	99	°C	Condenser temperature above which the condenser fan is switched on

F47	30	0	240	s	Condenser fan switch-off delay from when the compressor is switched off (only if the condenser probe is not present)
F48	0	0	1	----	Condenser fan status during defrosting 0 = off 1 = on
F49	0	0	1	----	Fan operating mode during conservation 0 = in parallel with the compressor 1 = always on
PAR.	DEFAULT	MIN.	MAX.	U.M.	DIGITAL INPUTS
i0	2	0	2	----	Effect of the door opening, or when the door switch input is activated 0 = no effect and no signal 1 = the compressor, evaporator fan, thawing heaters, heater and humidifier are switched off and the cabinet light is on, once the time set by parameter i2 has elapsed, the device displays the alarm and the buzzer is activated until the door is closed. See also parameter F15 2 = the evaporator fan is switched off and the cabinet light is on, once the time set by parameter i2 has elapsed, the device displays the alarm and the buzzer is activated until the door is closed. See also parameter F15
i1	0	0	1	----	Door switch input polarity 0 = normally open (input active with contact closed) 1 = normally closed (input active with contact open)
i2	5	-1	120	min	Door open duration for recording open door alarm and deactivating all outputs except light and alarm; -1 = alarm not signalled
i5	0	0	2	----	Function linked to multi-purpose digital input: 0 = high pressure switch 1 = low pressure switch 2 = compressor thermal switch
i6	0	0	1	----	Multi-purpose input polarity 0 = normally open (input active with contact closed) 1 = normally closed (input active with contact open)
i7	5	-1	240	s	Multi-purpose alarm signalling delay -1 = alarm not signalled

PAR.	DEFAULT	MIN.	MAX.	U.M.	DIGITAL OUTPUTS
u1	1	0	2	----	Load managed by output K4 0=door frame heater 1=condenser fan 2=thawing heater

u2	2	0	3	----	Load managed by output K5 0=cabinet light 1=UV lamp 2= needle probe heater 3=alarm
u5	2	-50	99	°C	Cabinet temperature over which the door heaters are switched off
u6	5	1	240	min	Time the UV lamp is on for the sterilisation cycle
u7	40	-50	199	°C	Temperature to end needle probe heating; see also parameter u8
u8	2	0	240	min	Maximum duration of needle probe heating; see also parameter u7 0 = needle probe heating is disabled
u11	0	0	1	----	Enable evaporator ventilation during sterilisation (only valid if u1=1) 0=no 1=yes
PAR.	DEFAULT	MIN.	MAX.	U.M.	SECURITY AND EVLINK DATA-LOGGING
Hr0	1	0	1	----	Enable clock 0 = no 1 = yes
Loc	----	----	----	----	Unused
PA1	426	-99	999	----	EVCONNECT APP level 1 password
PA2	824	-99	999	----	EVCONNECT APP level 2 password
rE0	5	1	240	min	EVLINK data recording interval during blast chilling, blast freezing, ice cream hardening and fish sanitation
rE1	1	0	2	----	Selection of values sampled by BLE data logger 0 = none 1 = HACCP data (cabinet temperature, needle, cycle duration, type of cycle, total blast chilling time, HACCP alarms) 2 = SERVICE data (all temperatures, all events, all alarms, all cycles)
bLE	1	0	1	----	Activate Bluetooth 0 = no 1 = yes
PAR.	DEFAULT	MIN.	MAX.	U.M.	MODBUS
LA	247	1	247	----	Device address

Lb	3	0	3	-----	Baud rate
					0 = 2,400 baud
					1 = 4,800 baud
					2 = 9,600 baud
					3 = 19,200 baud
LP	2	0	2	-----	Parity
					0 = none
					1 = odd
					2 = even

9 ALARMS

9.1 Alarms

The alarms will be displayed on the Home page if the effect is to interrupt or to prevent the activation of the cycle. If they are such as to allow the continuation of the cycle in progress they will instead take the place of the "cycle progress bar" until they disappear.

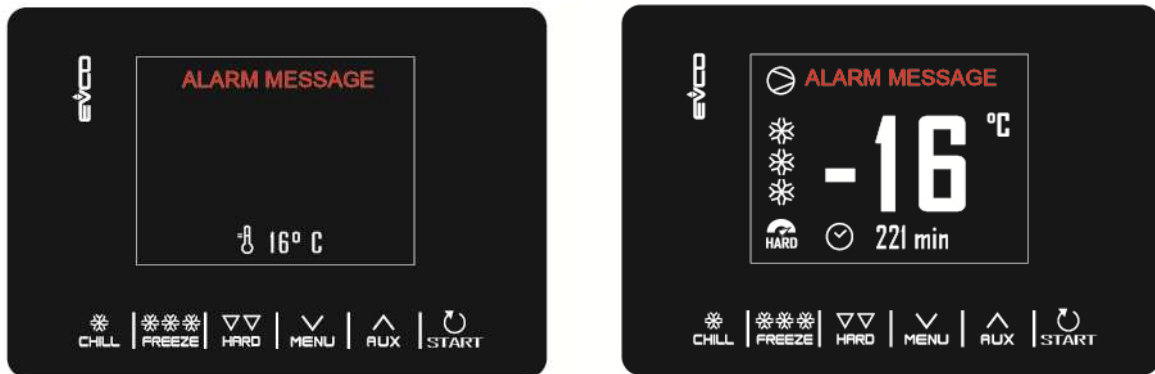

The table below lists the various alarms.

Code	Description
RTC	<p>Clock error.</p> <p>To correct:</p> <ul style="list-style-type: none"> - re-set the date and time. <p>Main results:</p> <ul style="list-style-type: none"> - the device will not save the date and time an HACCP alarm occurred. - the alarm output will be activated.
CABINET PROBE	<p>Cabinet probe error.</p> <p>To correct:</p> <ul style="list-style-type: none"> - check the value of parameter P0 - check the integrity of the probe - check the device-probe connection - check the cabinet temperature. <p>Main results:</p> <ul style="list-style-type: none"> - if the error occurs during "stand-by", it will not be possible to start up an operating cycle - if the error occurs during blast chilling or blast freezing, the cycle will continue with the compressor in continuous mode - if the error occurs during conservation, the compressor will operate according to parameters C4 and C5 or C9 - if the error occurs during a thawing cycle, the cycle will be interrupted - the minimum temperature alarm will never be activated - the maximum temperature alarm will never be activated - the door heaters will never be switched on - the alarm output will be activated

EVAPORATOR PROBE	<p>Evaporator probe error.</p> <p>To correct:</p> <ul style="list-style-type: none"> - the same as for the cabinet probe error but with reference to the evaporator probe. <p>Main results:</p> <ul style="list-style-type: none"> - if parameter P4 is set to 1, defrosting will last for the time set by parameter d3 - parameter F1 will have no effect - the alarm output will be activated
CONDENSER PROBE	<p>Condenser probe error.</p> <p>To correct:</p> <ul style="list-style-type: none"> - the same as for the cabinet probe error but with reference to the condenser probe. <p>Main results:</p> <ul style="list-style-type: none"> - the condenser fan will operate in parallel with the compressor - the condenser overheat alarm will never be activated - the compressor locked alarm will never be activated - the alarm output will be activated
NEEDLE PROBE	<p>Needle probe error.</p> <p>To correct:</p> <ul style="list-style-type: none"> - the same as for the cabinet probe error but with reference to the needle probe. <p>Main consequences if parameter P3 is set to 1:</p> <ul style="list-style-type: none"> - if the error occurs during stand-by, the temperature controlled cycles will be started up as time-controlled - if the error occurs during temperature controlled blast chilling, blast chilling will last for the time set by parameter r1 - if the error occurs during temperature controlled blast freezing, blast freezing will last for the time set by parameter r2 - if the error occurs during needle probe heating, the heating will be interrupted - the alarm output will be activated
THERMAL SWITCH	<p>Thermal switch alarm</p> <p>To correct:</p> <ul style="list-style-type: none"> - check the condition of the multi-purpose input - check the value of parameter i6. <p>Main results:</p> <ul style="list-style-type: none"> - the cycle underway will be interrupted - the alarm output will be activated
HIGH PRESSURE	<p>High pressure alarm.</p> <p>To correct:</p> <ul style="list-style-type: none"> - check the condition of the multi-purpose input - check the value of parameter i6. <p>Main results:</p> <ul style="list-style-type: none"> - if the cycle underway requires the use of the compressor, the cycle will be interrupted - the alarm output will be activated - the condenser fan will be switched on.

<p>LOW PRESSURE</p>	<p>Low pressure alarm.</p> <p>To correct:</p> <ul style="list-style-type: none"> - check the condition of the multi-purpose input - check the value of parameter i6. <p>Main results:</p> <ul style="list-style-type: none"> - if the cycle underway requires the use of the compressor, the cycle will be interrupted - the alarm output will be activated - the condenser fan will be switched on.
<p>DOOR OPEN</p>	<p>Door open alarm.</p> <p>To correct:</p> <ul style="list-style-type: none"> - check the condition of the door. <p>Main results:</p> <ul style="list-style-type: none"> - all outputs will be deactivated, except for the light output and the alarm output.
<p>HIGH TEMPERATURE</p>	<p>Maximum temperature alarm (HACCP alarm).</p> <p>To correct:</p> <ul style="list-style-type: none"> - check the cabinet temperature - check the value of parameters A4 and A5 <p>Main results:</p> <ul style="list-style-type: none"> - the device will save the alarm - the alarm output will be activated
<p>LOW TEMPERATURE</p>	<p>Minimum temperature alarm (HACCP alarm).</p> <p>To correct:</p> <ul style="list-style-type: none"> - check the cabinet temperature - check the value of parameters A1 and A2 <p>Main results:</p> <ul style="list-style-type: none"> - the device will save the alarm - the alarm output will be activated
<p>CYCLE DURATION</p>	<p>Alarm indicating that temperature controlled blast chilling or blast freezing has not been completed within the maximum duration (HACCP alarm).</p> <p>To correct:</p> <ul style="list-style-type: none"> - check the value of parameters r5 and r6 <p>Main results:</p> <ul style="list-style-type: none"> - the device will save the alarm - the alarm output will be activated
<p>POWER FAILURE</p>	<p>Power failure alarm (HACCP alarm).</p> <p>To correct:</p> <ul style="list-style-type: none"> - check the device-power supply connection. <p>Main results:</p> <ul style="list-style-type: none"> - the device will save the alarm - any cycle underway will resume when power is restored - the alarm output will be activated

<p>SANITATION PROBE INSERTION</p>	<p>Sanitation alarm.</p> <p>To correct:</p> <ul style="list-style-type: none"> - check that the needle probe has been correctly inserted and check the value of parameters r17 and r18. <p>Main results:</p> <ul style="list-style-type: none"> - the sanitation cycle will be interrupted.
<p>SANITATION DURATION</p>	<p>Alarm indicating that sanitation has not been completed within the maximum duration of the first phase.</p> <p>To correct:</p> <ul style="list-style-type: none"> - check the value of parameter r23 <p>Main results:</p> <ul style="list-style-type: none"> - the device will save the alarm - the cycle underway will be interrupted - the alarm output will be activated
<p>CONDENSER OVERHEATING</p>	<p>Condenser overheat alarm.</p> <p>To correct:</p> <ul style="list-style-type: none"> - check the condenser temperature - check the value of parameter C6. <p>Main results:</p> <ul style="list-style-type: none"> - the condenser fan will be switched on - the alarm output will be activated
<p>COMPRESSOR LOCKED</p>	<p>Compressor locked alarm.</p> <p>To correct:</p> <ul style="list-style-type: none"> - check the condenser temperature - check the value of parameter C7 - disconnect the device from the power supply and clean the condenser. <p>Main results:</p> <ul style="list-style-type: none"> - if the error occurs during "stand-by", it will not be possible to select or start up an operating cycle - if the error occurs during an operating cycle, the cycle will be interrupted. - the alarm output will be activated
<p>NEEDLE PROBE INSERTION</p>	<p>Needle probe not inserted alarm.</p> <p>To correct:</p> <ul style="list-style-type: none"> - check that the needle probes have been correctly inserted and check the value of parameters r17 and r18. <p>Main results:</p> <ul style="list-style-type: none"> - the temperature controlled cycle in progress will be converted to a time controlled cycle.

10 TECHNICAL SPECIFICATIONS

10.1 Technical specifications

Purpose of the control device	Function controller	
Construction of the control device	Built-in electronic device	
Container	Black, self-extinguishing	
Category of heat and fire resistance	D	
Measurements	111.4 x 76.4 x 48.0 mm (4 3/8 x 3 x 1 15/16 in)	
Mounting methods for the control device	Front installation model:	to be fitted to a plastic or metal panel, with elastic holding flaps
	Model for installing behind glass or methacrylate:	with double-sided tape
Degree of protection provided by the casing	IP65 (front), provided that the device is installed on a metal panel 0.8 mm (1/32 in) thick	
Connection method	<ul style="list-style-type: none"> - Fixed screw terminal blocks for wires up to 2.5 mm² (plug-in screw terminal blocks for wires up to 2.5 mm² on request) - Pico-Blade connector 	
	Maximum permitted length for connection cables: <ul style="list-style-type: none"> - power supply: 10 m (32.8 ft) - analogue inputs: 10 m (32.8 ft) - digital inputs: 10 m (32.8 ft) - digital outputs: 10 m (32.8 ft) 	
Operating temperature	from -5 to 55 °C (from 23 to 131 °F)	
Storage temperature	from -25 to 70 °C (from -13 to 158 °F)	
Operating humidity	relative humidity without condensate from 10 to 90%	
Pollution status of the control device	2	
Compliance	<ul style="list-style-type: none"> - RoHS 2011/65/EC - WEEE 2012/19/EU - REACH (EC) Regulation no. 1907/2006 - EMC 2014/30/EU - LVD 2014/35/EU 	
Power supply	230 VAC (+10 % -15 %), 50/60 Hz (±3 Hz), max. 6 VA	
Earthing methods for the control device	none	

Rated impulse-withstand voltage	2.5 KV
Over-voltage category	II
Software class and structure	A
Clock	Available in EVJ815 (with built-in secondary lithium battery) but not available in EVJ805
	Clock drift: ≤ 60 s/month at 25 °C (77 °F)
	Clock battery autonomy in the absence of a power supply: > 24 h at 25 °C (77 °F)
	Clock battery charging time: 24 h (the battery is charged by the power supply of the device)
Analogue inputs	2 for PTC or NTC probes (cabinet probe and needle probe)
	<i>PTC probes</i>
	Sensor type: KTY 81-121 (990 Ω @ 25 °C, 77 °F) Measurement field: from -50 to 150 °C (from -58 to 302 °F) Resolution: 1 °C (1 °F)
	<i>NTC probes</i>
Sensor type: B3435 (10 K Ω @ 25 °C, 77 °F) Measurement field: from -40 to 105 °C (from -40 to 221 °F) Resolution: 1 °C (1 °F)	
Analogue-digital inputs	1 input can be configured for analogue input (auxiliary probe) or digital input (multi-purpose input)
Digital inputs	1 dry contact (door switch) Contact type: 5 VDC, 1.5 mA Power supply: none
Digital outputs	5 with electro-mechanical relay (compressor, defrost, evaporator fan, auxiliary 1 and auxiliary 2) Compressor relay: SPST, 30 A res. @ 250 VAC Defrost relay: SPDT, 8 A res. @ 250 VAC Evaporator fan relay: SPST, 8 A res. @ 250 VAC Auxiliary relay 1: SPST, 5 A res. @ 250 VAC Auxiliary relay 2: SPST, 5 A res. @ 250 VAC
	The device guarantees reinforced insulation between each digital output connector and the rest of the components of the device.
Type 1 or Type 2 Actions	Type 1

Additional features of Type 1 or Type 2 actions	C
Displays	2.8 inch TFT graphic display, 16 colours, 320 x 240 pixel resolution
Alarm buzzer	Built-in
Communications ports	1 TTL slave port for EVJKEY programming key, for EVlink (to operate the EVconnect app) or for TTL/RS-485 EVIF22TSX serial interface.

EVJ800

Controller for blast chillers
with 2.8 inch TFT colour graphic display
with capacitive keypad
Installer manual ver. 1.0
GA - 18/18
Code 144J800E104

This document and the solutions contained therein are the intellectual property of EVCO and thus protected by the Italian Intellectual Property Rights Code (CPI). EVCO imposes an absolute ban on the full or partial reproduction and disclosure of the content other than with the express approval of EVCO. The customer (manufacturer, installer or end-user) assumes all responsibility for the configuration of the device. EVCO accepts no liability for any possible errors in this document and reserves the right to make any changes, at any time without prejudice to the essential functional and safety features of the equipment.



EVCO S.p.A.

Via Feltre 81, 32036 Sedico Belluno ITALY

Tel. 0437 / 8422

Fax 0437 / 83648

info@evco.it

www.evco.it